

Industrial Wall-mount Managed Gigabit Ethernet Switch

WGS-5225-8T2SV

WGS-5225-8P2SV

WGS-5225-8P2S

Quick Installation Guide

Table of Contents

1. Package Contents	3
2. Requirements	4
3. Wiring the Power Inputs.....	5
3.1 Terminal Block Connector Pinout	6
4. Installation.....	7
4.1 Wall-mount Installation	7
4.2 Magnet Installation	8
4.3 DIN-rail Installation	8
5. Web Login.....	10
5.1 Starting Web Management	10
5.2 Saving Configuration via the Web	12
6. Telnet Login	13
6.1 Configuring IP Address.....	13
6.2 Storing the Current Switch Configuration	15
7. Recovering Back to Default Configuration.....	16
8. LCD Touch Screen.....	17
9. Customer Support	19









1. Package Contents

Thank you for purchasing PLANET Industrial Wall-mount Managed Gigabit Switch, WGS-5225-8T2SV/WGS-5225-8P2SV/WGS-5225-8P2S. The table below shows the models with the number of ports:

Model Name	10/100/1000T Copper Ports	802.3at PoE Ports	100/1000X SFP Ports	2.4" LCD
WGS-5225-8T2SV	8	-	2	■
WGS-5225-8P2SV	8	8	2	■
WGS-5225-8P2S	8	8	2	-

In the following section, unless specified, the term **"Wall-mount Managed Switch"** mentioned in this quick installation guide refers to the WGS-5225-8T2SV/WGS-5225-8P2SV/WGS-5225-8P2S.

Open the box of the Wall-mount Managed Switch and carefully unpack it. The box should contain the following items:

The Wall-mount Managed Switch x 1	Quick Installation Guide x 1	Wall-mounted Kit x 1
		
DIN-rail Kit x 1	Magnet Kit x 1	3-pin Terminal Block Connector x 1
		
RJ45 Dust Cap x 8	SFP Dust Cap x 2	
		

If any item is found missing or damaged, please contact your local reseller for replacement.

2. Requirements

- Workstations running Windows XP/2003/Vista/7/8/2008/10, MAC OS X or later, Linux, UNIX, or other platforms are compatible with TCP/IP protocols.
- Workstations are installed with Ethernet NIC (Network Interface Card)
- Ethernet Port Connection
 - Network cables -- Use standard network (UTP) cables with RJ45 connectors.
 - The above PC is installed with Web browser and JAVA runtime environment plug-in.



Note

It is recommended to use Internet Explore 8.0 or above to access the Wall-mount Managed Switch. If the Web interface of the Wall-mount Managed Switch is not accessible, please turn off the anti-virus software or firewall and then try it again.

3. Wiring the Power Inputs

The Wall-mount Managed Switch features a strong dual power input system (Terminal block and DC jack) incorporated into customer's automation network to enhance system reliability and uptime.

Model \ Power Input Range	3-pin Terminal Block	DC Jack
WGS-5225-8T2SV	12~48V DC, 24V AC	12~48V DC, 24V AC
WGS-5225-8P2SV	48~56V DC	48~56V DC
WGS-5225-8P2S	48~56V DC	48~56V DC

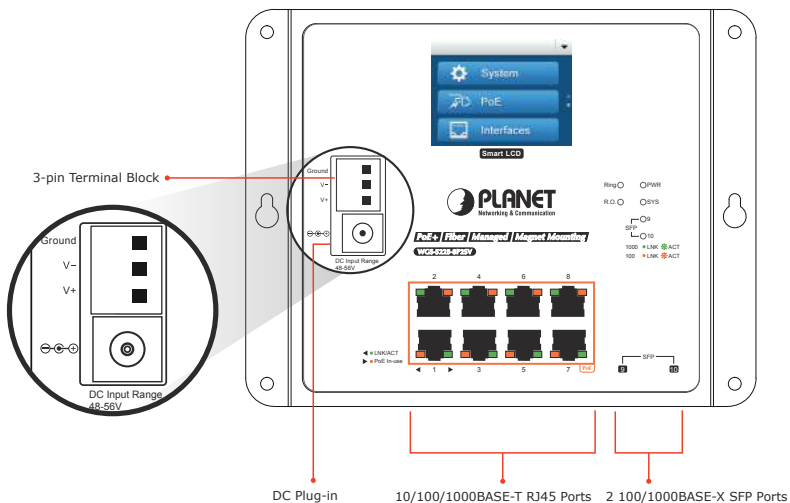

3.1 Terminal Block Connector Pinout

To install the 3-pin Terminal Block Connector on the Wall-mount Managed Switch, simply follow the following steps:

Step 1: Insert positive DC power wire into V+, negative DC power wire into V-, and grounding wire into Ground.

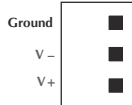

Step 2: Tighten the wire-clamp screws for preventing the wires from loosening and plug them into the Wall-mount Managed switch



Note

1. The wire gauge should be in the range from 12 to 24 AWG.
2. The device must be grounded.

4. Installation

4.1 Wall-mount Installation

To install the Wall-mount Managed Switch on the wall, simply follow the following steps:

- Step 1:** There are 4 holes with 8mm diameter on the wall; the distance between the 2 holes is 165mm and the line through them must be horizontal.
- Step 2:** Install a conductor pipe inside the board hole and flush the edge of the conductor pipe with the wall surface.
- Step 3:** Screw the bolts into the conductor pipe. The Wall-mount Managed Switch is between bolts and conductor pipe, as shown below.

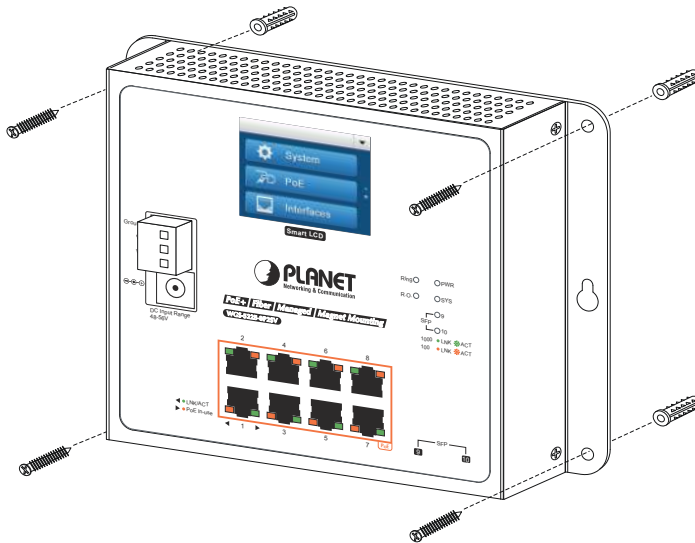

4.2 Magnet Installation

To install the Wall-mount Managed Switch on a magnetic surface, simply follow the following diagram:

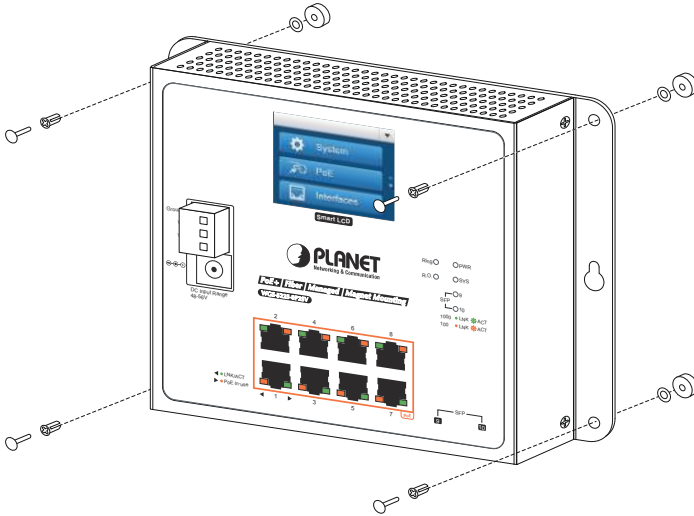

4.3 DIN-rail Installation

The DIN-rail kit is included in the package. When the wall-mount application for the Wall-mount Managed Switch needs to be replaced with DIN-rail application, please refer to the following figures to screw the DIN-rail on the Wall-mount Managed Switch. To hang up the Wall-mount Managed Switch, follow the steps below:

Step 1: Screw the DIN-rail on the Wall-mount Managed Switch.

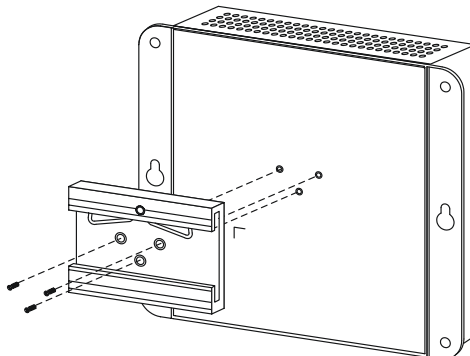

Step 2: Lightly insert the button of DIN-rail into the track.

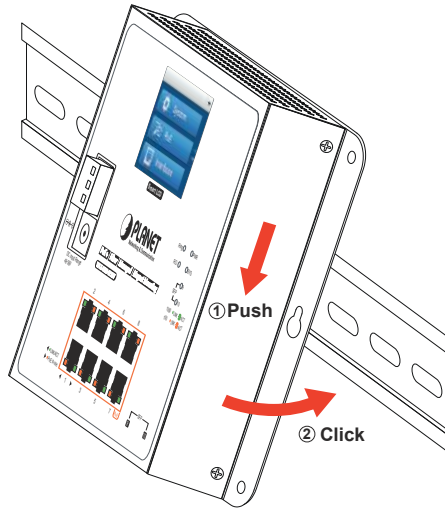

Step 3: Check whether the DIN-rail is tightly on the track.

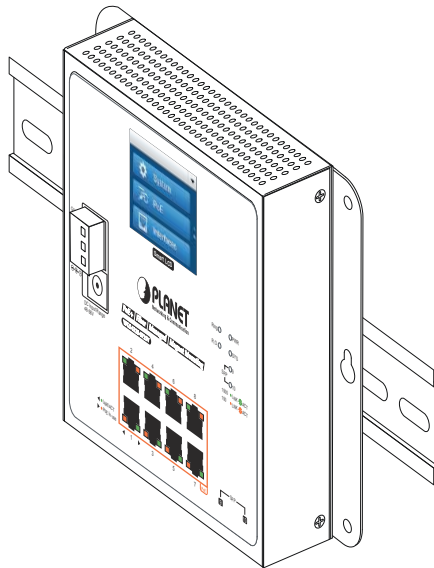

5. Web Login

5.1 Starting Web Management

The following shows how to start up the **Web Management** of the Wall-mount Managed Switch. Note the Wall-mount Managed Switch is configured through an Ethernet connection. Please make sure the manager PC must be set to the same **IP subnet address**.

For example, the default IP address of the Wall-mount Managed Switch is **192.168.0.100**, then the manager PC should be set to **192.168.0.x** (where x is a number between 1 and 254, except 100) and the default subnet mask is 255.255.255.0.

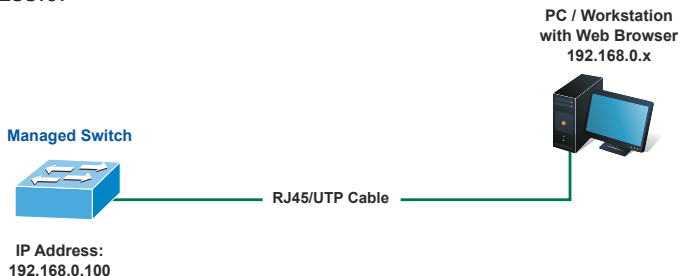

Figure 5-1: IP Management Diagram

Logging in to the Wall-mount Managed Switch

1. Use Internet Explorer 8.0 or above Web browser and enter IP address <http://192.168.0.100> to access the Web interface.
2. When the following dialog box appears, please enter **"admin"** in both the default user name and password fields. The login screen in Figure 5-2 appears.

Default IP Address: **192.168.0.100**
Default Username: **admin**
Default Password: **admin**

The screenshot shows a web browser dialog box titled 'Authentication required'. It displays the URL 'http://192.168.0.100' and a warning: 'Your connection to this site is not private'. Below this are two input fields: 'Username' and 'Password'. At the bottom right, there are two buttons: 'Log in' (highlighted in blue) and 'Cancel'.

Figure 5-2: Web Login Screen

3. After entering the password, the main screen appears as Figure 5-3 shows.



Note

The following web screen is based on the WGS-5225-8P2S. The display of the WGS-5225-8P2SV is the same as those of the WGS-5225-8T2SV and WGS-5225-8P2SV.



Figure 5-3: Web Main Screen of Wall-mount Managed Switch

The Switch Menu on the left of the Web page lets you access all the commands and statistics the Wall-mount Managed Switch provides.



Figure 5-4: Switch Menu

Now, you can use the Web management interface to continue the Switch management. Please refer to the user's manual for more.

5.2 Saving Configuration via the Web

In the Wall-mount Managed Switch, the running configuration file stores in the RAM. In the current version, the running configuration sequence of **running-config** can be saved from the RAM to FLASH by executing save startup config command, so that the running configuration sequence becomes the startup configuration file, which is called configuration save.

To save all applied changes and set the current configuration as a startup configuration, the startup-configuration file will be loaded automatically across a system reboot.

1. Click **System, Save Startup Config**.



2. Press the "Save Configuration" button.

Save Running Configuration to startup-config

Save Configuration

6. Telnet Login

The Wall-mount Managed Switch also supports telnet for remote management. The switch asks for user name and password for remote login when using telnet; please use “admin” for both username and password.

Default IP Address: **192.168.0.100**
Username: **admin**
Password: **admin**

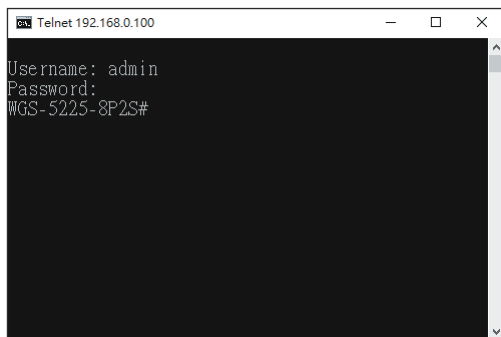

Figure 6-1: Wall-mount Managed Switch Telnet Login Screen

The user can now enter commands to manage the Wall-mount Managed Switch. For a detailed description of the commands, please refer to the following chapters.



Note

1. For security reason, please change and memorize the new password after this first setup.
2. Only accept command in lowercase letter under console interface.

6.1 Configuring IP Address

The Wall-mount Managed Switch is shipped with default IP address shown below:

IP Address: **192.168.0.100**
Subnet Mask: **255.255.255.0**

To check the current IP address or modify a new IP address for the Switch, please use the procedure as follows:

■ Display of the Current IP Address

1. At the “#” prompt, enter “**show ip interface brief**”.
2. The screen displays the current IP address shown in Figure 6-2.

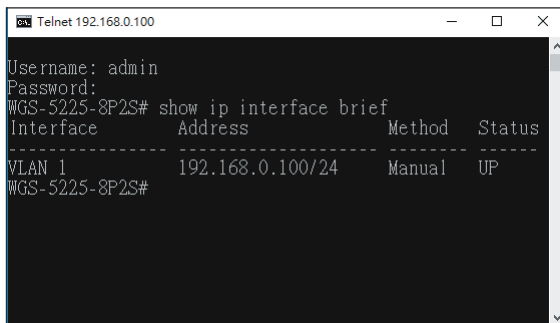

```
Telnet 192.168.0.100
Username: admin
Password:
WGS-5225-8P2S# show ip interface brief
Interface      Address          Method  Status
-----
VLAN 1        192.168.0.100/24 Manual  UP
WGS-5225-8P2S#
```

Figure 6-2: IP Information Screen

■ Configuration of the IP Address

3. At the “#” prompt, enter the following command and press **<Enter>** as shown in Figure 6-3.

```
WGS-5225-8P2SV# configure terminal
WGS-5225-8P2SV (config)# interface vlan 1
WGS5225-8P2SV (config-if-vlan)# ip address 192.168.1.100 255.255.255.0
```

The previous command would apply the following settings for the Wall-mount Managed Switch.

```
IP Address: 192.168.1.100
Subnet Mask: 255.255.255.0
```

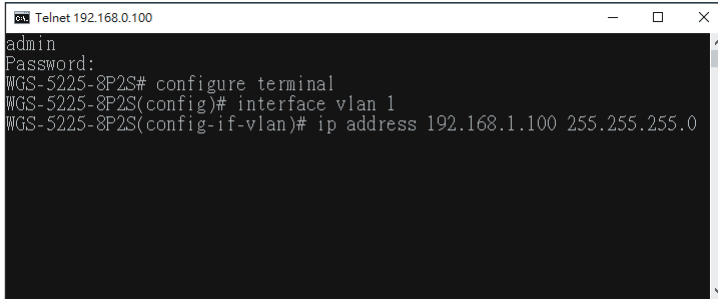

```
Telnet 192.168.0.100
admin
Password:
WGS-5225-8P2S# configure terminal
WGS-5225-8P2S(config)# interface vlan 1
WGS-5225-8P2S(config-if-vlan)# ip address 192.168.1.100 255.255.255.0
```

Figure 6-3: Configuring IP Address Screen

4. Repeat step 1 to check if the IP address has changed.

6.2 Storing the Current Switch Configuration

At the “#” prompt, enter the following command and press **<Enter>**.

```
# copy running-config startup-config
```



```
Telnet 192.168.1.100
admin
Password:
WGS-5225-8P2S# copy running-config startup-config
Building configuration...
do not reset or power off the device!
.
% Saving 2325 bytes to flash:startup-config
WGS-5225-8P2S#
```

Figure 6-4: Saving Current Configuration Command Screen

If the IP is successfully configured, the Wall-mount Managed Switch will apply the new IP address setting immediately. You can access the Web interface of the Wall-mount Managed Switch through the new IP address.



Note

If you are not familiar with the console command or the related parameter, enter “**help**” anytime in console to get the help description.

7. Recovering Back to Default Configuration

■ IP Address has been changed or admin password has been forgotten –

To reset the IP address to the default IP address “**192.168.0.100**” or reset the login password to default value, press the **reset button** on the front panel for about **5 seconds**. After the device is rebooted, you can log in to the Web interface management within the same subnet of 192.168.0.xx.

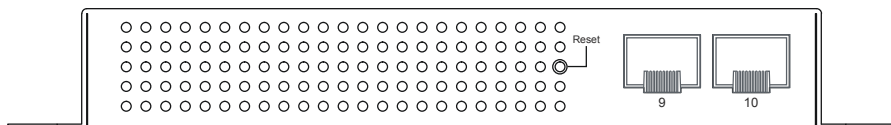

Figure 7-1: Wall-mount Managed Switch Reset Button

8. LCD Touch Screen

The WGS-5225-8P2SV and WGS-5225-8T2SV have a 2.4-inch color LCD touch screen with management functions. Tap the LCD touch screen to wake the LCD touch screen.



Figure 8-1: To wake the LCD touch screen

The factory default LCD configurations are shown as follows.

Default LCD: **Enable**
Default Touch Screen: **Enable**
Default Backlight Timeout: **Enable**
Default Backlight Timeout Time: **300**
Default Read Only Mode: **Disable**
Default Screen: **Main Menu**
Default Time Interval: **10**
Default Color Scheme: **Dark**
Default Pin Number: **1234**

You can use the Web management interface and click LCD, and then in the LCD Management, change LCD configuration.



LCD Management

LCD	Enable ▾
Touch Screen	Enable ▾
Backlight Timeout	Enable ▾
Backlight Timeout Time	300
Read Only Mode	Disable ▾
Default Screen	Main Menu ▾
Time Interval	10
Color Scheme	<input checked="" type="radio"/> Dark <input type="radio"/> Light
Pin Number	1234

Please refer to the user's manual for more.

9. Customer Support

Thank you for purchasing PLANET products. You can browse our online FAQs resource and User's Manual on PLANET Web site first to check if it could solve your issue. If you need more support information, please contact PLANET switch support team.

PLANET online FAQs:

<http://www.planet.com.tw/en/support/faq.php?type=1>

Switch support team mail address:

support_switch@planet.com.tw

WGS-5225-8T2SV/WGS-5225-8P2SV/WGS-5225-8P2S User's Manual:

<http://www.planet.com.tw/en/support/download.php?type1=22153&model=&type=3>



Copyright © PLANET Technology Corp. 2017.

Contents are subject to revision without prior notice.

PLANET is a registered trademark of PLANET Technology Corp. All other trademarks belong to their respective owners.

